

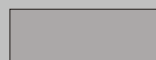

Área de impresión (para diámetro interior 35 mm.)

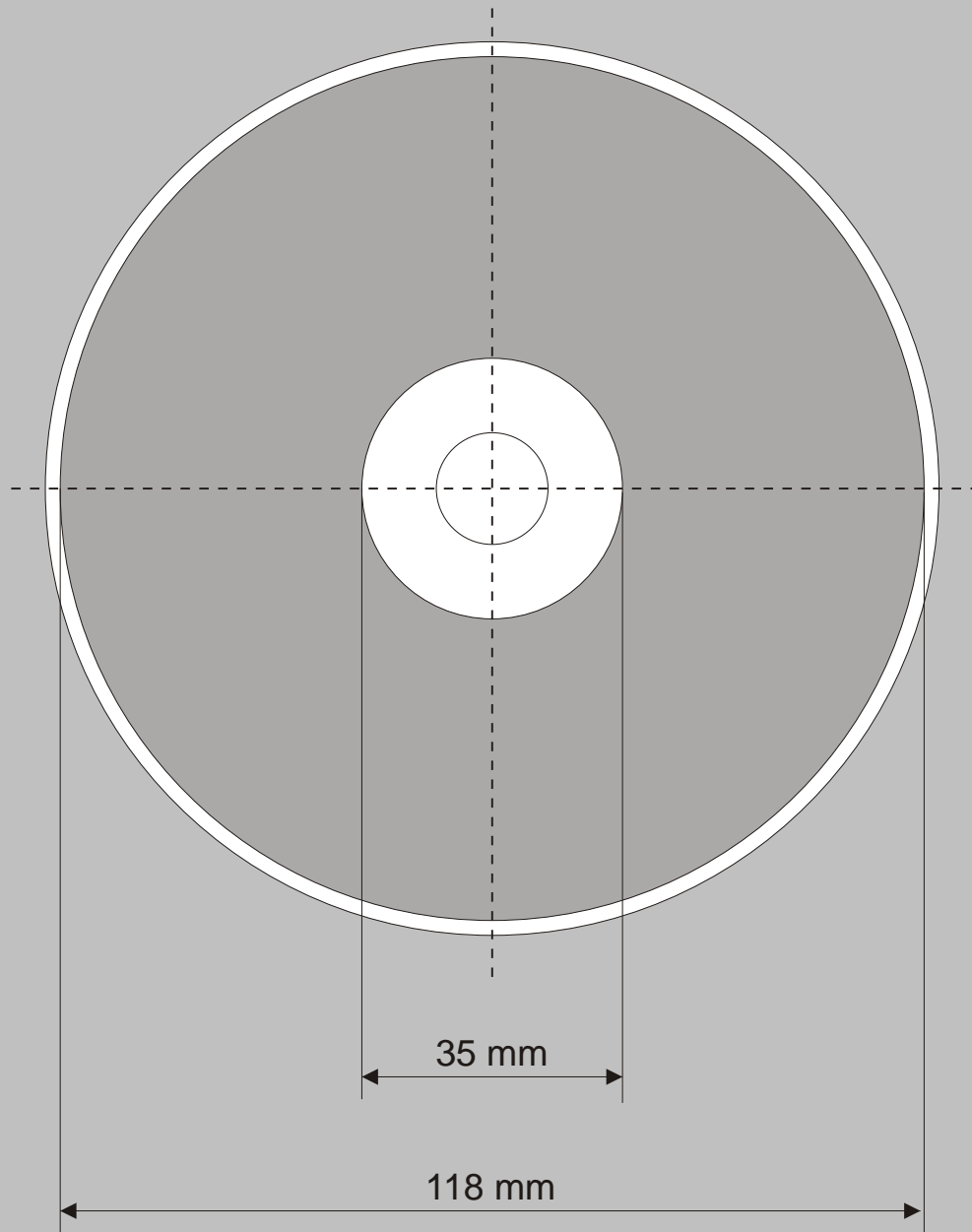

Zona de impresión